

PHC 08B-1X5MTR

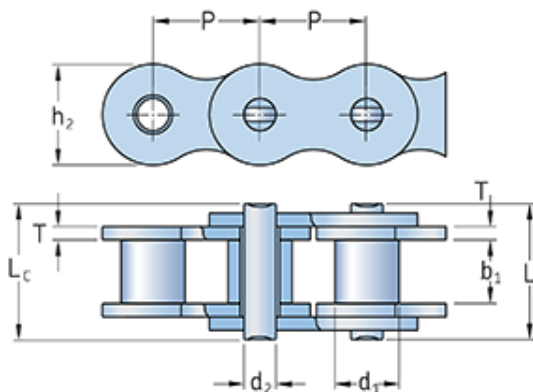

Pitch P (mm)	12.7
Roller diameter d1 max (mm)	8.51
Width between inner plates b1 min (mm)	7.75
Pin diameter d2 max (mm)	4.45
Plate height h2 max (mm)	11.8
Plate thickness T max (mm)	1.6
Weight (kg/m)	0.69